

# EK.06

## TIRNAKLI KILAVUZLAR

### TRAP GUIDES





EK 06.101

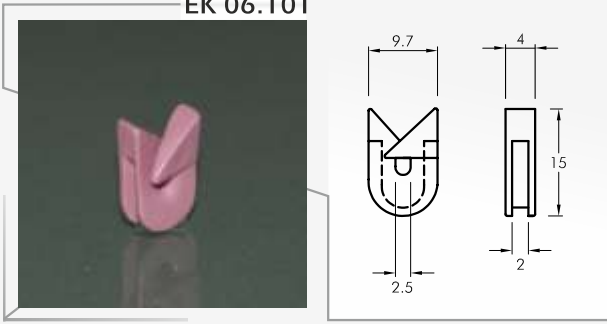

EK 06.102

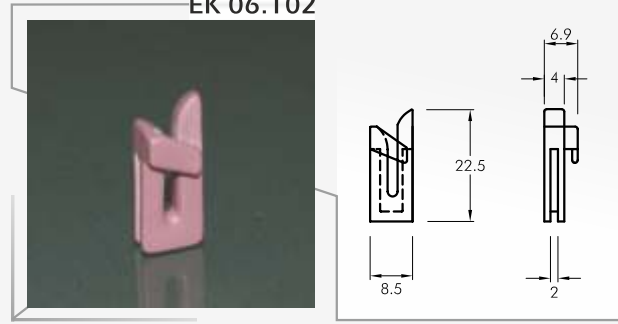

EK 06.103

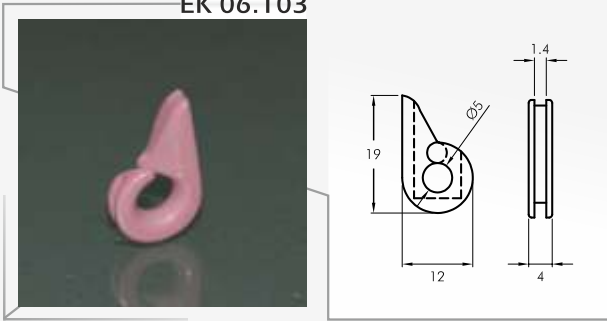

EK 06.104

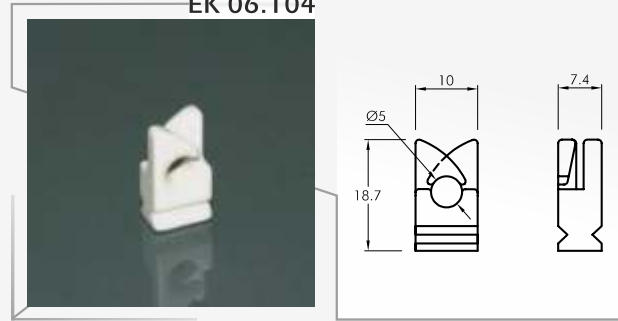

EK 06.105

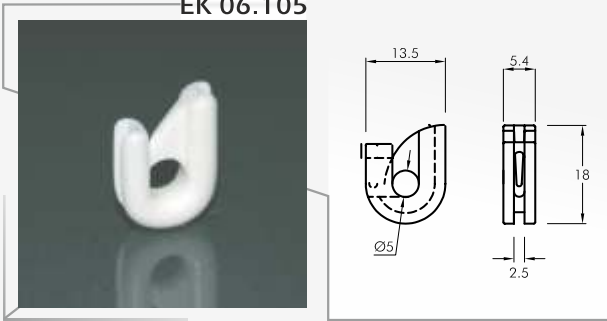

EK 06.106

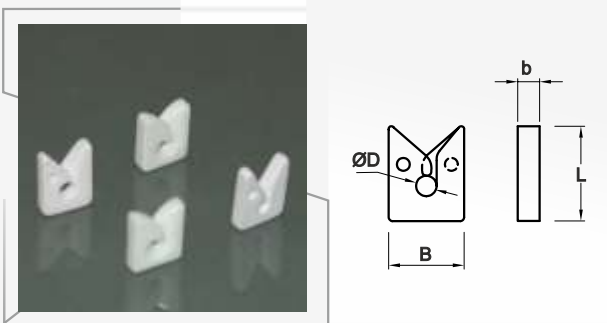
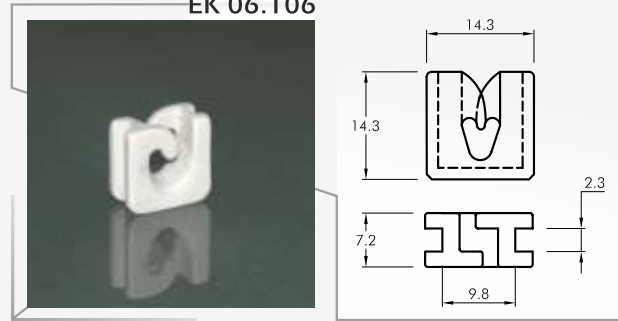

KOD NO	ØD	L	B	b
EK.06.107	2.8	13.1	10.1	2.9
EK.06.148	1.8	13.5	10.3	2.7
EK.06.159	1.8	12	10	3.1
EK.06.160	1.3	11.8	10	3

EK 06.108

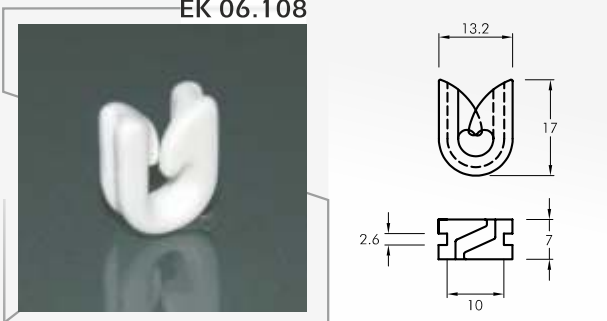

EK 06.109

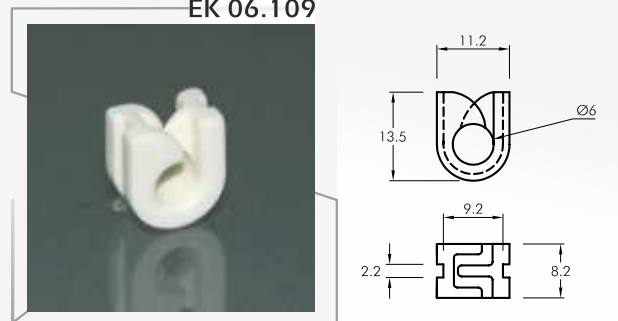

EK 06.110

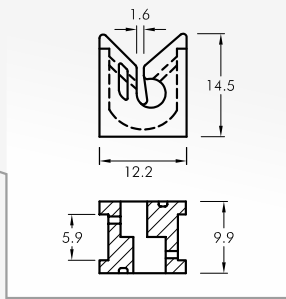

EK 06.111

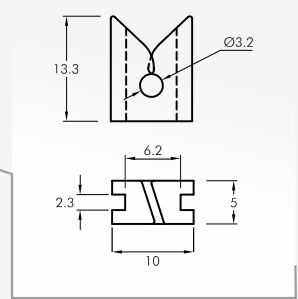

EK 06.112

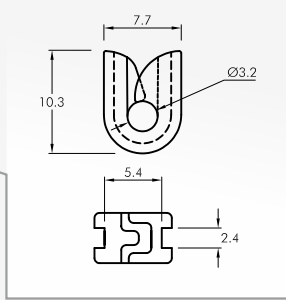

EK 06.113

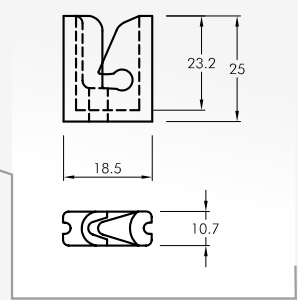

EK 06.114

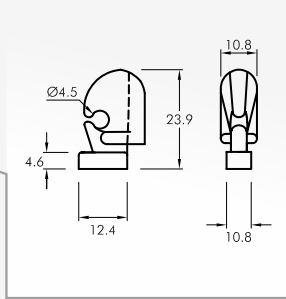

EK 06.115

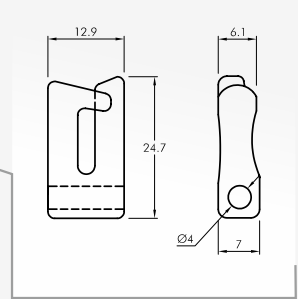

EK 06.116

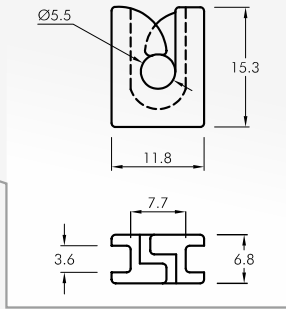

EK 06.117

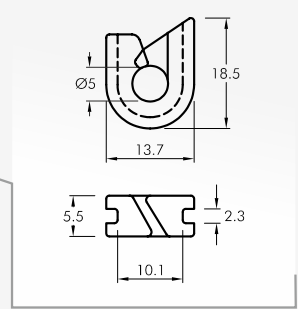

EK 06.118

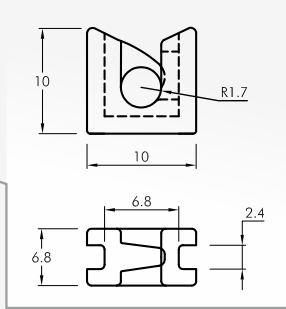

EK 06.119

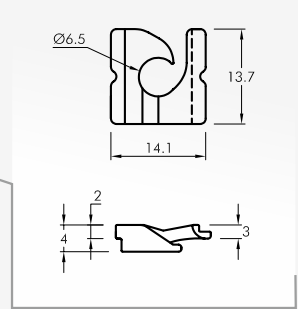

EK 06.120

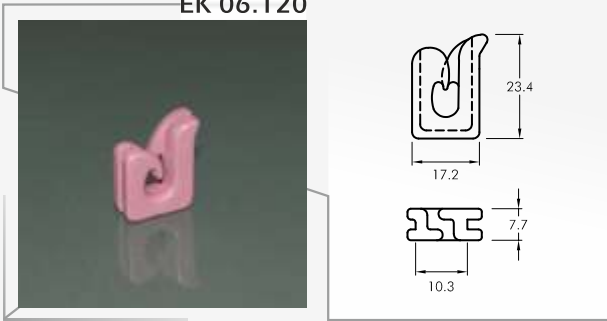

EK 06.121

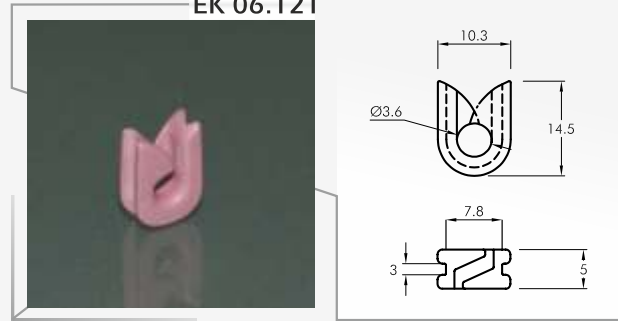

EK 06.122

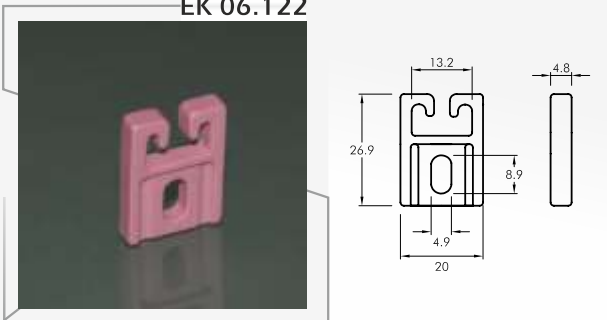

EK 06.123

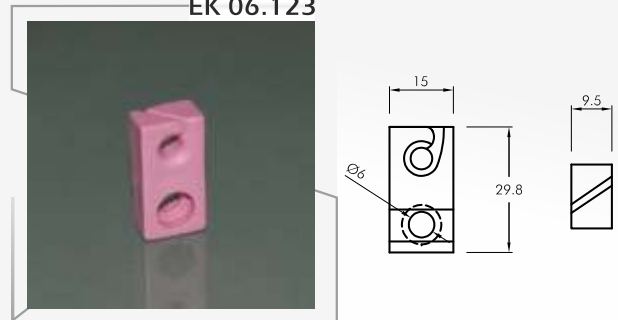

EK 06.124

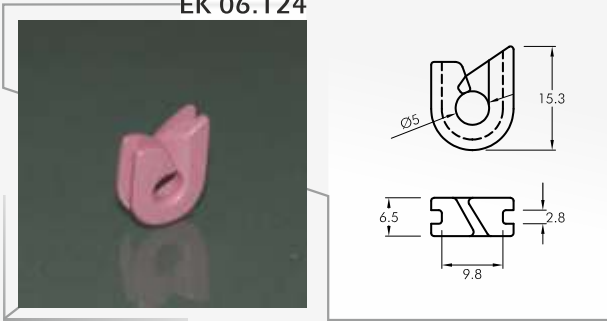

EK 06.125

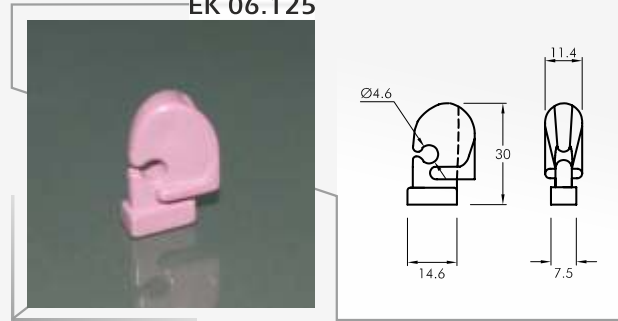

EK 06.126

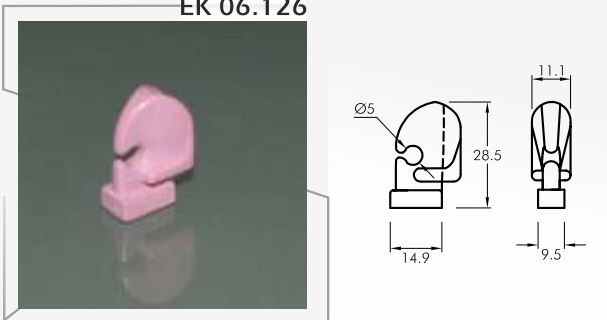

EK 06.127



EK 06.128

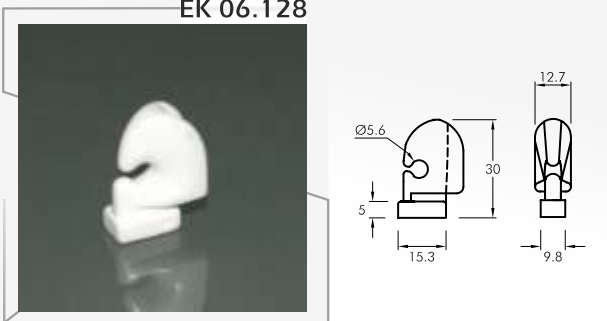

EK 06.129

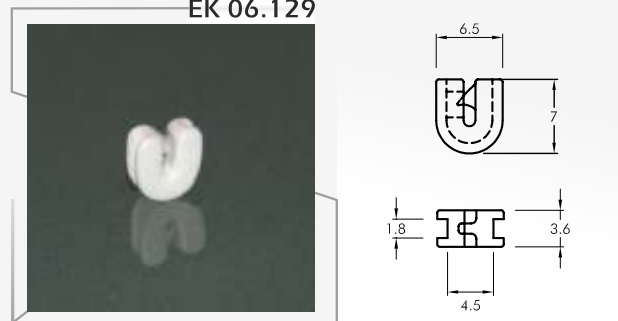

EK 06.130

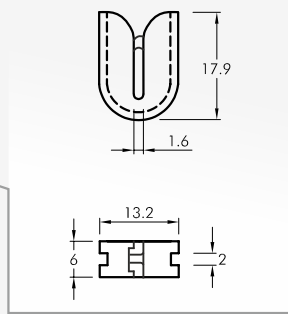

EK 06.131

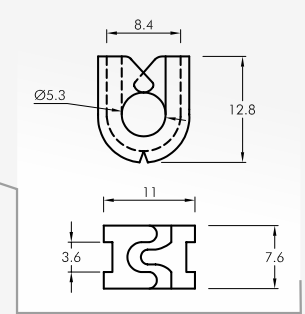

EK 06.132

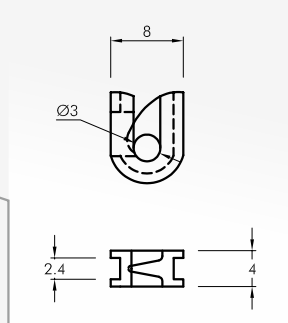
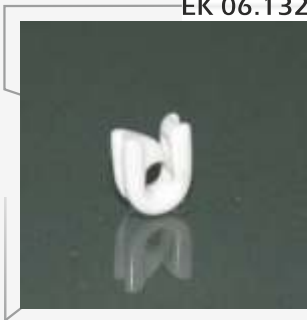

EK 06.133

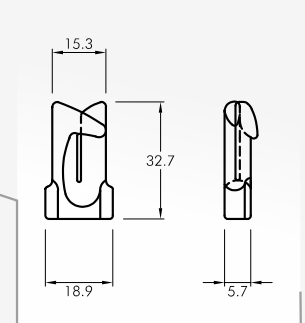

EK 06.134

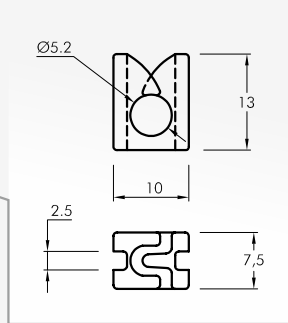

EK 06.135

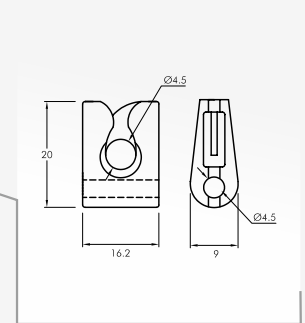

EK 06.136

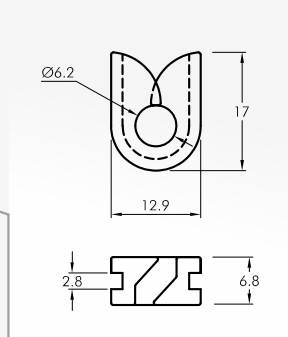

EK 06.137

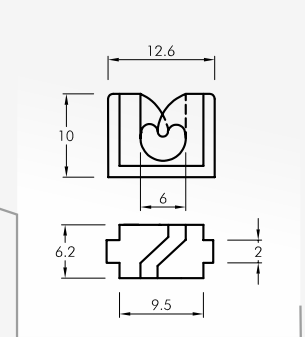

EK 06.138

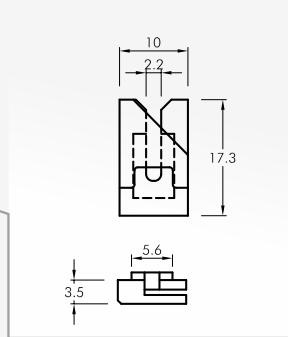
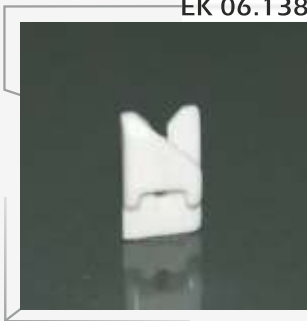

EK 06.139

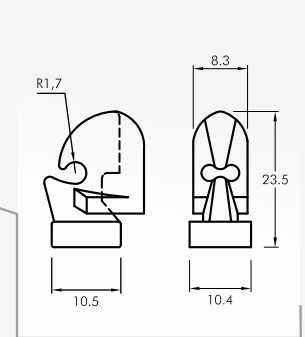

EK 06.140

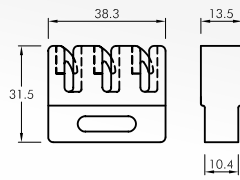
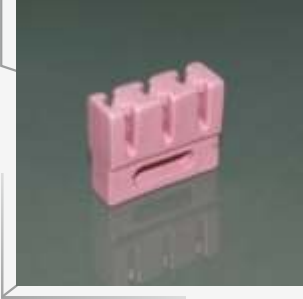

EK 06.141

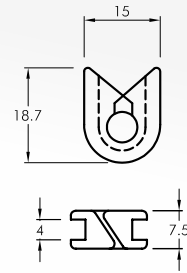

EK 06.142

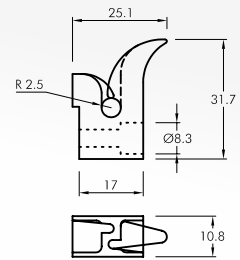

EK 06.143

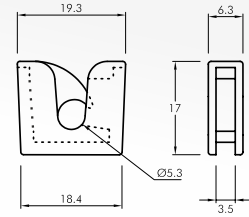

EK 06.144

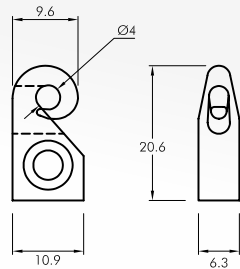

EK 06.145

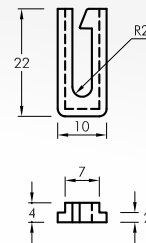
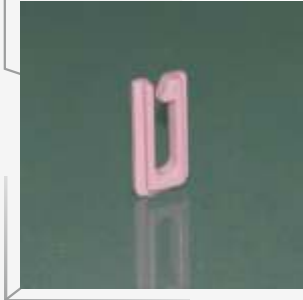

EK 06.146

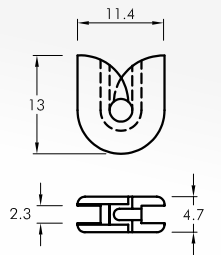
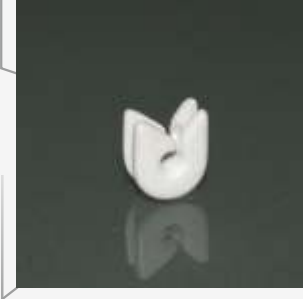

EK 06.147

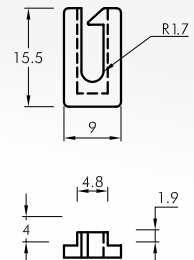
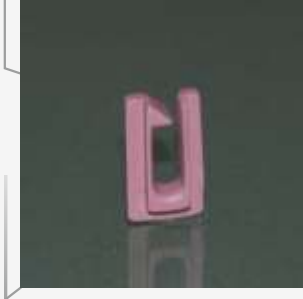

EK 06.149

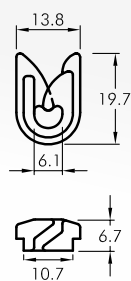

EK 06.150

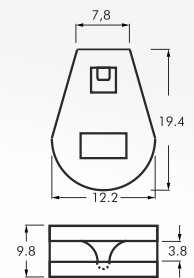
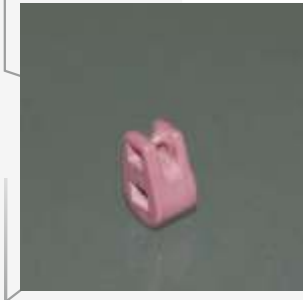

EK 06.151

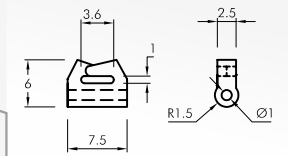

EK 06.152

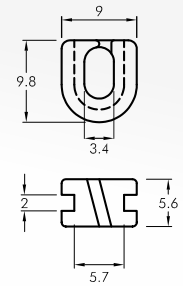

EK 06.153

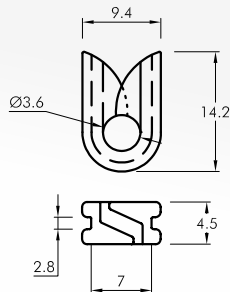

EK 06.154

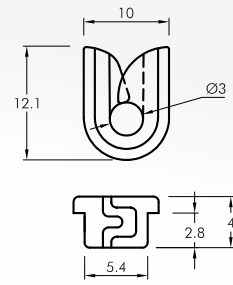

EK 06.155

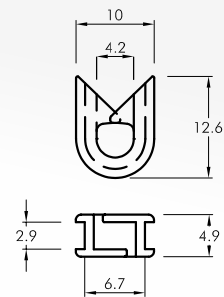
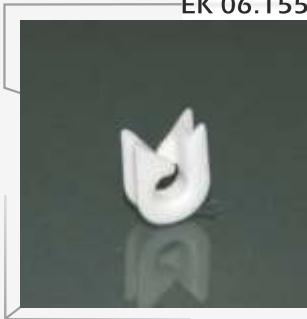

EK 06.156

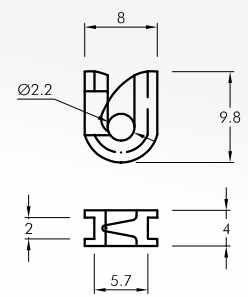

EK 06.157

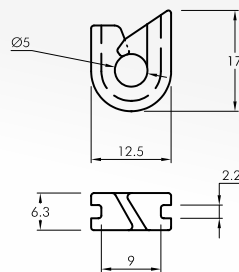
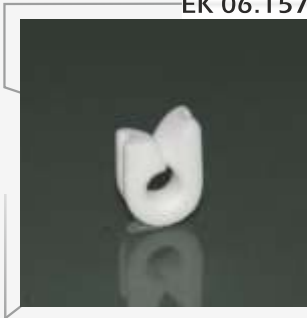

EK 06.158

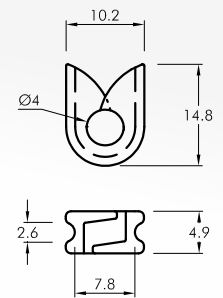

EK 06.161

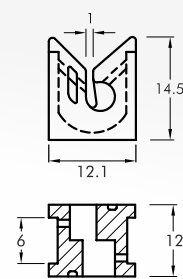
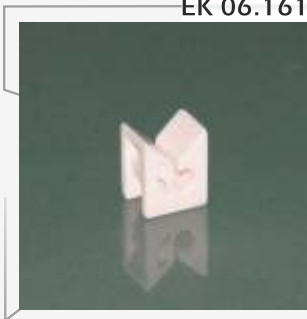

EK 06.162

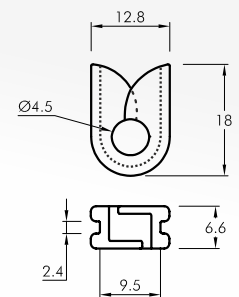



EK 06.163

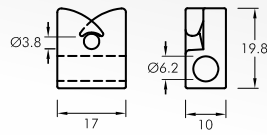

EK 06.164

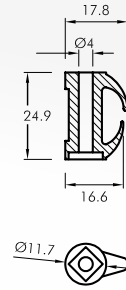

EK 06.165

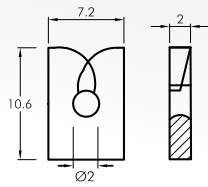

EK 06.166

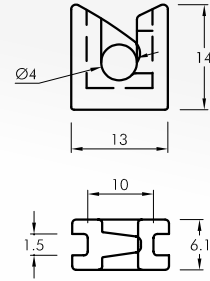

EK 06.167

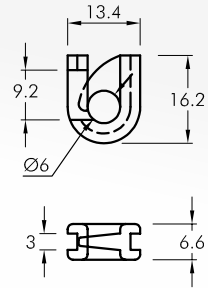

EK 06.168

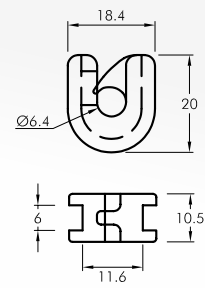
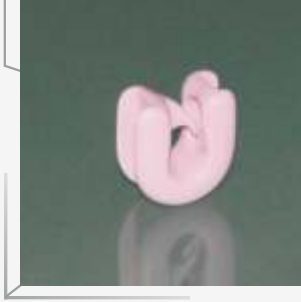

EK 06.169

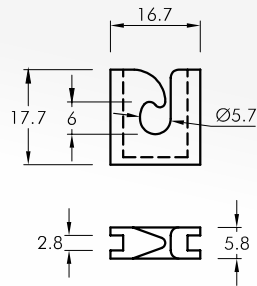
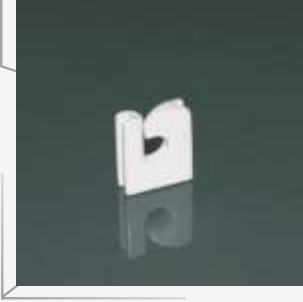

EK 06.170

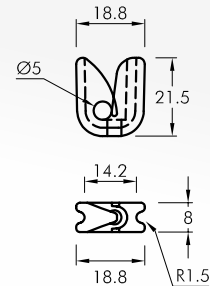

EK 06.171

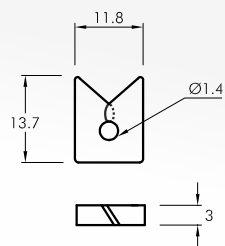

EK 06.172

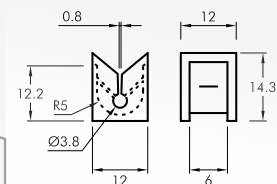

EK 06.173

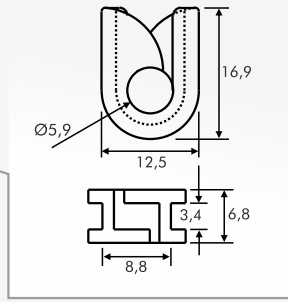
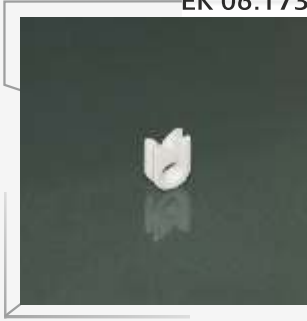

EK 06.174

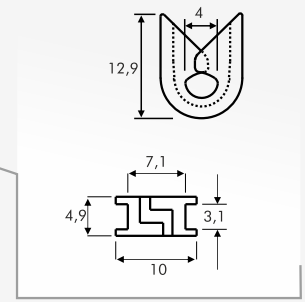
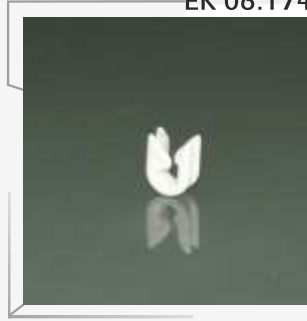

EK 06.175

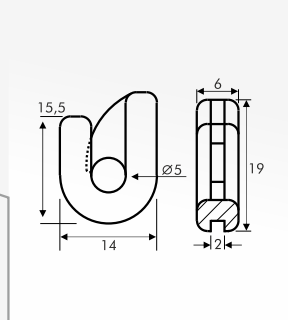

EK 06.176

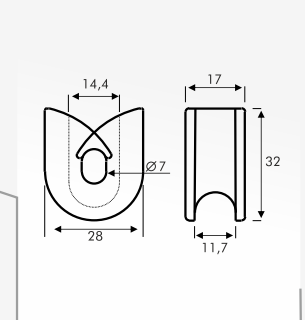
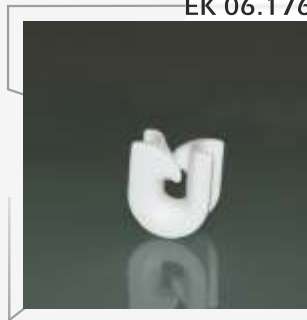

EK 06.177

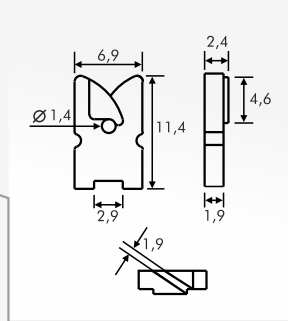
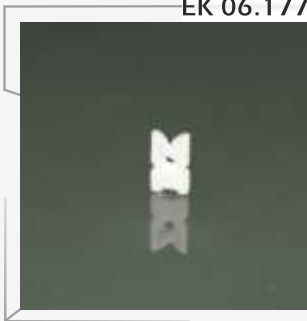

EK 06.178

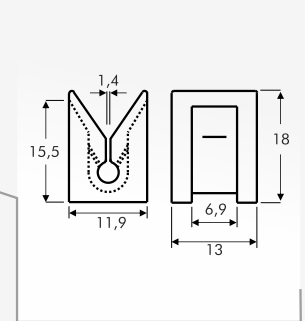

EK 06.179

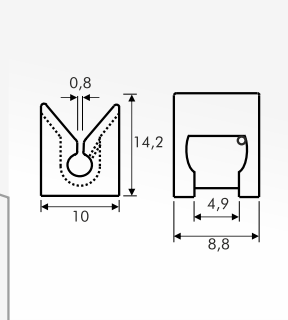

EK 06.180

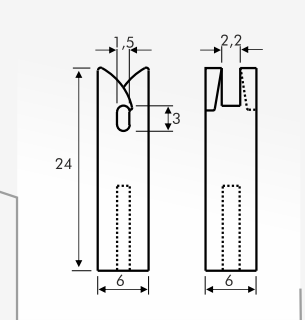

EK 06.181

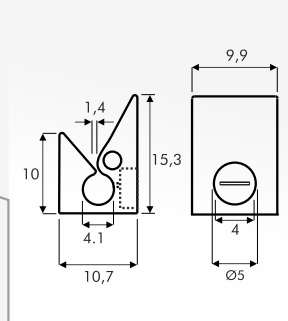
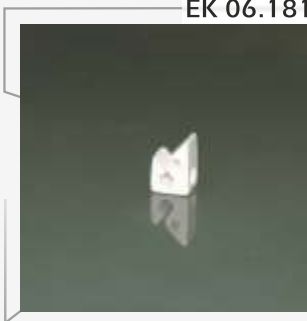

EK.06.183

